

Owner's Manual

ADP303 Dolby® Digital Decoder

Table of Contents

Introduction and Safety Information 1-3

Front Panel Controls 4

Rear Panel Connections 5

Installation & Set Up 6-7

Connections with AVR80 or AVI250 8

Connections with an External Surround Sound Processor 9

Connections with AV Receiver through Pre-out/Main-In Loop 10

ADP303 Operation 11

Specifications 11

Troubleshooting Guide 12

CAUTION

RISK OF ELECTRICAL SHOCK
DO NOT OPEN

CAUTION: TO REDUCE THE RISK OF ELECTRIC SHOCK, DO NOT REMOVE COVER (OR BACK), NO USER-SERVICEABLE PARTS INSIDE. REFER SERVICING TO QUALIFIED SERVICE PERSONNEL.

<p>The lightning flash with arrowhead symbol, within an equalateral triangle, is intended to alert the user to the presence of uninsulated "dangerous voltage" within the product's enclosure that may be of sufficient magnitude to constitute a risk of electric shock to persons.</p>	<p>The exclamation point within an equalateral triangle is intended to alert the user to the presence of important operating and maintenance (servicing) instructions in the literature accompanying the appliance.</p>
--	---

WARNING: TO REDUCE THE RISK OF FIRE OR ELECTRIC SHOCK, DO NOT EXPOSE THIS APPLIANCE TO RAIN OR MOISTURE.

CAUTION: TO PREVENT ELECTRIC SHOCK, MATCH WIDE BLADE OF PLUG TO WIDE SLOT, FULLY INSERT.

ATTENTION: POUR EVITER LES CHOCS ELECTRIQUES, INTRODUIRE LA LAME LA PLUS LARGE DE LA FICHE DANS LA BORNE CORRESPONDANTE DE LA PRISE ET POUSSER JUSQU'AU FOND.

harman/kardon
80 Crossways Park West
Woodbury, NY 11797

H A Harman International Company
©1996 Harman Kardon, Incorporated

Introduction and Safety Information

1

Congratulations! Your purchase of an ADP303 places you in the vanguard of home theater listeners. The ADP303's advanced circuitry decodes the Dolby Digital (AC-3) signals from standard laser discs, the latest DVD players and other future digital audio sources to deliver six separate, discrete audio channels. The realism of AC-3 finally allows you to hear motion picture soundtracks and music videos with the digital clarity of the best first run movie theater.

While complex systems are hard at work within the ADP303 to decode the digital audio, hook-up and operation are simple. However, to obtain the maximum enjoyment from your new decoder we urge you to take a few minutes to read through this manual. This will ensure that connections to source playback units, receivers or amplifiers and other external devices are made properly. In addition, a few minutes spent learning the functions of the various controls will enable you to take advantage of all the processing power the ADP303 is able to deliver.

If you have any questions about this product, it's installation or operation, please contact the retailer or custom installer who sold you the product. They are your best source of local information.

IMPORTANT SAFETY INFORMATION

Verify Line Voltage Before Use

Your ADP303 has been designed for use with 230 volt AC current. Connection to a line voltage other than that for which it is intended can create a safety and fire hazard, and may damage the decoder.

If you have any questions about the voltage requirements for your specific model, or about the line voltage in your area, contact your selling dealer before plugging the unit into a wall outlet.

Do Not Use Extension Cords

To avoid safety hazards, use only the power cord supplied with your unit. If a replacement cord is used, make certain that it is of similar gauge. We do not recommend that extension cords be used with this product. As with all electrical devices, do not run power cords under rugs or carpets or place heavy objects on them. Damaged power cords should be replaced immediately with cords meeting factory specifications.

Handle the AC Power Cord Gently

When disconnecting the power cord from an AC outlet, always pull the plug, never pull the cord. If you do not intend to use the decoder for any considerable length of time, disconnect the plug from the AC outlet.

Do Not Open The Cabinet

There are no user serviceable components inside this product. Opening the cabinet may present a shock hazard, and any modification to the product will void your warranty. If water or any metal object such as a paper clip, wire or a staple accidentally falls inside the unit, disconnect it from the AC power source immediately, and consult an authorized service station.

Installation Location

- To assure proper operation, and to avoid the potential for safety hazards, place the unit on a firm and level

surface. When placing the unit on a shelf, be certain that the shelf and any mounting hardware can support the weight of the product.

- Make certain that proper space is provided both above and below the unit for ventilation. If this product will be installed in a cabinet or other enclosed area, make certain that there is sufficient air movement within the cabinet.
- Do not place the unit directly on a carpeted surface.
- Avoid installation in extremely hot or cold locations, or an area that is exposed to direct sunlight or heating equipment.
- Avoid moist or humid locations.
- Do not obstruct the ventilation slots on the top of the unit, or place objects directly over them.

Cleaning

When the unit gets dirty, wipe it with a clean, soft dry cloth. If necessary, wipe it with a soft cloth dampened with mild soapy water, then a fresh cloth with clean water. Wipe dry immediately with a dry cloth. NEVER use benzene, thinner, alcohol or any other volatile cleaning agent. Do not use abrasive cleaners, as they may damage the finish of metal parts. Avoid spraying insecticide near the unit.

Moving The Unit

Before moving the unit, be certain to disconnect any interconnection cords with other components, and make certain that you disconnect the unit from the AC outlet.

Introduction and Safety Information

UNPACKING & INSTALLATION

The carton and shipping materials used to protect your new ADP303 during shipment were specially designed to cushion it from shock and vibration. We suggest that you save the carton and packing materials for use in shipping if you move or should the unit ever need repair.

To minimize the size of the carton in storage, you may wish to flatten it. This is done by carefully slitting the tape seams on the bottom and collapsing the carton down to a more two dimensional appearance. Other cardboard inserts may be stored in the same manner. Packing materials that cannot be collapsed should be saved along with the carton in a plastic bag.

If you do not wish to save the packaging materials, please note that the carton and other sections of the shipping protection are recyclable. Please respect the environment and discard those materials at a local recycling center.

When positioning your ADP303 in its final location, make certain that any shelf or stand is capable of supporting its weight, and that there is adequate ventilation on all sides, as well as on the top and bottom. Do not place CD's, record jackets, owner's manuals, or other paper on top of, or beneath the unit. This will block air flow and create a potential fire hazard. If the unit is to be enclosed in a cabinet or rack, make certain that there is adequate air circulation, with a means provided for hot air to exit, and for cool air to be brought in.

WHAT IS DOLBY DIGITAL?

Dolby Digital, or AC-3 as it is often referred to, is a totally new generation of multi-channel digital audio technology. Using advanced circuit designs and specially developed compression techniques, AC-3 delivers significant advances over previous multi-channel systems: it delivers noise free, wide bandwidth sound and it includes six separate audio channels.

AC-3 evolves from Dolby Laboratories' constant research into new ways to deliver high quality audio for theatrical motion picture presentation and transmission via satellite and telecommunications links. In fact, the "AC" in AC-3 stands for "Audio Coding," the technique used in Dolby Digital for data compression.

The ADP303 digital demodulator/decoder brings that same 5.1 channel high quality sound that accompanies many major motion pictures into your home when used with a compatible laser disc player, as well as from future Dolby Digital sources such as DSS, Digital Video Disc (DVD) and High Definition Television (HDTV).

For today's Laser Disc systems the digital audio signal is recorded as a modulated RF signal, similar to the signals used for FM and TV broadcasts. That is why connections to a laser disc are made through an "RF" input. New technology products such as DVD will feature direct data outputs, and they are connected directly to the ADP303's decoding circuitry, without the need for the demodulator stage. Both Coaxial and Optical data inputs are available.

Traditional "stereo" recordings consist of two channels, left and right, even though the original intent of sound engineers was to have a multitude of channels available to present a realistic audio soundfield. Unfortunately, early recording techniques for vinyl records

and optical movie soundtracks were limited to two channels. Dolby Surround was the technology that broke the two channel barrier, by placing two additional channels within the left and right signals.

Those two additional channels presented center channel information, primarily for movie dialog, and a single, mono rear channel for effects. The combination of these two channels with the existing left and right signals and low frequency information derived via filters or an electronic crossover gave home theater and musical presentations a realism never before possible.

Dolby Digital takes surround sound to a new and even higher level. The use of digital recording techniques enables all surround channels to be full range, where the surround channel in older matrix surround systems is frequency limited. Dolby Digital also delivers six separate, discrete channels, including highly defined left and right surround channels. With two rear channels instead of the single, mono channel of Dolby ProLogic there is a greater feeling of reality and presence for surround effects such as "flyovers" of planes and spaceships. Discrete digital sound also enables complete separation between the left front, center, right front, right rear and left rear channels. The matrix system used in conventional surround recordings was often plagued with cross talk between the channels. That is now gone with Dolby Digital.



Introduction and Safety Information

3

WHAT IS 5.1 CHANNEL AUDIO?

So far we have mentioned five channels, yet Dolby Digital is a six channel system. You may have also heard this system referred to as "5.1" channel audio. Where, you may ask, is the sixth channel, and what is the ".1" channel?

The answer is simple. The sixth channel is a special low frequency effects channel, or "LFE". This is the bass channel that sends the thunder of explosions and other effects to your subwoofer.

It is separate from the other five channels, bringing the total channel count to six. This is true even though the "sixth" channel is non-directional, as opposed to the highly directional nature of the other signals. The reason for the ".1" designation is that the LFE channel is bandwidth limited. By definition, the LFE channel has a restricted bandwidth, while the others are full range. Thus, the system's inventors decided that although they could call Dolby Digital a six channel system, since there are six separate channels, it is more properly five "full" channels plus one separate, but limited channel.

In this case, "5.1" equals six!

DESCRIPTION AND FEATURES

- High quality Dolby Digital decoding chip, manufactured by Zoran.
- AC-3 RF input, for connection to compatible laser disc players with AC-3 RF output.
- Coax and Optical Digital AC-3 inputs, for connection to other sources, such as DVD and/or DSS.
- Individual channel level controls and internal test tone generator, for precise system setup.
- Master volume control and mute function.
- Adjustable delay time.
- Bypass feature.
- Rear panel speaker configuration switches to match the ADP303 to a wide range of speaker types and sizes.
- 6 discrete channel inputs and outputs, for connection between existing surround sound pre-amp/processors and power amplifiers, featuring RCA jacks for full compatibility with high quality A/V cables.
- Dolby Digital AC-3 indicator light, shows the presence of AC-3 coding.

CONVENTIONS

In order to help you use this manual and make the proper system connections, certain conventions appear throughout the manual.

A – (letter in a circle) indicates a specific front panel control

1 – (number in a circle) indicates a rear panel connection

▲ – (number in a triangle) indicates a specific step in the installation instructions

Front Panel Controls

4

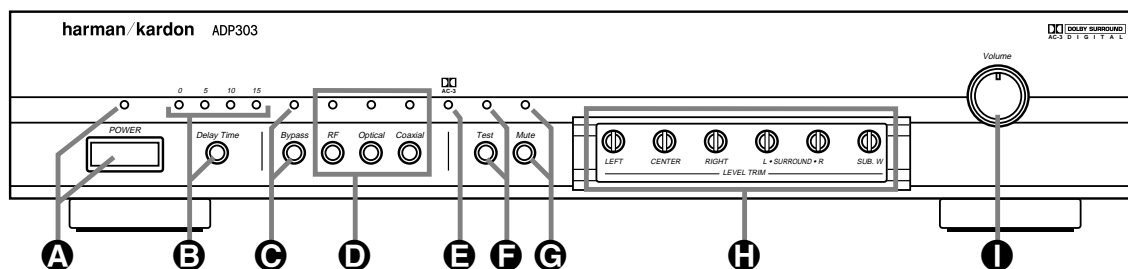

A Power Switch

Push this switch once to turn it on. Press it again to turn the unit off. An indicator above the power switch will illuminate when the unit is turned on.

B Delay Time Button and Indicators

Press this button to set the delay time for the surround channels. Each press of the button changes the delay time by 5 milliseconds. The delay time range is from no delay to 15 milliseconds. The indicator LEDs above the Delay Time button indicate the delay setting.

C Bypass Input Selector Button Indicator

Press this button to remove the ADP303 from the circuit when it is installed between a preamp and amplifiers. An indicator LED above the button will light to indicate the BYPASS mode.

D Digital Source Selectors

Press one of these buttons to select the digital input source. An indicator above the buttons will illuminate to confirm the selections.

E AC-3 Indicator

This LED will illuminate when a digital source is selected and the decoder has successfully locked to the incoming digital signal.

F Test Button and Indicator

This button activates the test signal that is used when adjusting output levels. When the button is tapped once the test noise will circulate between the speakers at a two (2) second interval. When you press and hold the button for a few seconds the test noise will circulate for five (5) seconds at each speaker. The red indicator above the button will illuminate when the test noise is present to remind you that the audio output has momentarily been changed. Press the button at any time when the noise is heard to cancel the test.

Note: The test signal noise is not available when the ADP303 is in the BYPASS mode. The test signal does not circulate to the subwoofer in any mode.

It is suggested that the five second test noise be used for initial adjustment of the output levels, and the shorter two second circulation be used as a final brief check after adjustments have been made.

G Mute Button and Indicator

Press this button to momentarily silence the audio output of the ADP303. Press it again to resume normal operation. An indicator light above the button will illuminate when the MUTE button is engaged to remind you that the unit is turned on, but silenced. The MUTE function will not work when the ADP303 is in the BYPASS mode.

H Level Trim Controls

These controls are used to adjust the audio output level of each individual channel. Use the small Allen wrench supplied with the ADP303 to remove the cover when adjustment of the level trims is required.

I Volume Control

This knob adjusts the master volume level of the ADP303's output. Turn it clockwise to increase the volume and counterclockwise to decrease the volume.

When the ADP303 is used in a system where the receiver/amplifier (such as the AVR80) has a "6 Channel Direct" input, the volume should be set to the "12 o'clock" position.

Rear Panel Connections

5

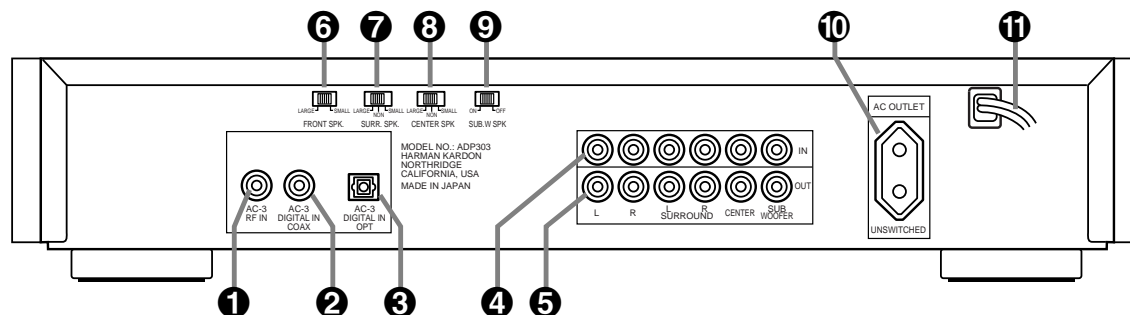

1 AC-3 RF IN Jack

Connect the AC-3 RF Output jack of a compatible Laser Disc player here.

2 AC-3 Digital IN - Coax Jack

These terminals are for connection to the coax data AC-3 output of future AC-3 digital products such as DVD, DSS and HDTV.

3 AC-3 Digital IN - Optical Jack

These terminals are for connection to the optical data AC-3 output of future AC-3 digital products such as DVD, DSS and HDTV. To avoid dust contamination, leave the protective cap inserted unless the jack is in use.

IMPORTANT NOTE: These input jacks are for AC-3 digital signals only. Do not connect standard audio outputs or the PCM digital output of an LV or CD player to these AC-3 Input Jacks.

4 6 Channel Input Jacks

When the ADP303 is used with an external preamplifier, an outboard surround processor or any AV receiver with PREAMP-OUT/MAIN-INPUT jacks, connect these jacks to the outputs of the preamp or processor.

5 6 Channel Output Jacks

These jacks deliver the outputs of the AC-3 decoder or pass through the inputs from a preamplifier/processor (see item 4) when the ADP303 is in the BYPASS mode. Depending on your application, they will either be connected to the "6 Channel Direct" inputs of products such as the AVR80 or directly to external power amplifiers.

6 Front SPK Switch

This switch determines if low frequency signals are sent to the front left/right speakers. The factory default "Small" sends them to the subwoofer output only, while "Large" sends a full range signal to the front left/right speakers.

7 Surr SPK Switch

This switch determines if low frequency signals are sent to the surround speakers. The factory default, "Small," sends them to the subwoofer output only, while "Large" sends a full range signal to the surround speakers. Select "none" if you will not use surround speakers and to route surround audio to the front left/right speakers.

8 Center SPK Switch

This switch determines if low frequency signals are sent to the center speaker. The factory default, "Small," sends them to the subwoofer output only, while "Large" send a full range signal to the center speaker. Select "none" if you will not use a center speaker and to route center channel audio to the front left/right speakers.

9 Subwoofer switch

This switch, in conjunction with the other "SPK" switches, directs the output of low frequency (LFE) signals. If a subwoofer is used, select "ON" to send all system sound below 100 Hz to the subwoofer output. If the "OFF" position is used, the LFE output will be directed to either the front left/right or center speaker outputs, depending on the position of switches 6 and 8.

Caution: When you want to change settings of any of these switches, 6 7 8 9 you must turn the power switch off and back on in order to effect the changes you want.

10 AC Outlet (Unswitched)

This unswitched outlet will supply power to any device in your system as long as the ADP303 is connected to AC power, even when the ADP303's power switch is in the off position.

The maximum power this outlet can supply is 200 watts.

11 Power cable

Connect the power cable to an unswitched AC power outlet. Plug into a household AC power outlet.

Installation & Setup

6

INSTALLATION

The ADP303 delivers optimal performance when it is used with the Harman Kardon AVR80 or AVI250 although it is also compatible with many other home theater system configurations. Please follow the instructions in this section that describe the equipment and speaker choices that most closely resemble that of your own system. Depending on the equipment in use, some of the switches and settings may require adjustment, while in other cases they may be left in their factory preset positions.

Depending on the specific equipment in your home theater setup, the ADP303 can be connected in one of three configuration options:

- Direct connection to A/V products such as the Harman Kardon AVR80 or AVI250 that feature a SIX CHANNEL DIRECT INPUT.
- Connection between an existing A/V surround processor/pre-amp and your power amplifier(s) and subwoofer (for owners of separates-based home theater systems).
- Connection to the PRE-OUT/MAIN-IN jacks on the rear panel of your A/V receiver, provided that it is equipped with 5 pre-out/main-in jack pairs and a subwoofer output jack.

SPEAKER SELECTION

The home theater system you already have installed should work with the ADP303 provided that there are left, center and right front speakers, left and right rear/surround speakers and a subwoofer. For best results we recommend that the front speakers be of the same type, with identical or similar driver units. This will deliver smooth pans across the front sound stage as the action moves from side to side.

Rear channel speakers need not be identical to the front channel speakers, but they should be of high quality. One of the benefits of Dolby Digital AC-3 is that the surround channels are full range, while they were frequency limited in earlier ProLogic type systems.

Bass effects are also an important part of home theater. For optimal enjoyment a subwoofer should be used as it is optimized for low frequency reproduction. If you have large full range front speakers, however, they may be used in place of a subwoofer with proper setting of the rear panel switches.

For the best advice on speaker selection consult your Harman Kardon dealer.

SPEAKER MODE SETTINGS

Since the ADP303 may be used with a wide variety of speaker types, it is important that you adjust the rear panel speaker mode switches before use. Setting these switches will tell the ADP303 what type of speakers you are using so that the audio outputs will be directed to the proper speaker.

In general, a "Large" speaker is defined as a traditional full range speaker that includes a woofer or some prepackaged "satellite/subwoofer" systems and is capable of reproducing sounds below 100 Hz. For the purposes of this product, a "Small" speaker is one that is not capable of delivering sounds significantly below 100 Hz. (Most "satellite" type speakers fall into this category.) Before setting the switches make note of the type of front, center and rear speakers that will be used. For further clarification of your speakers' type consult the speaker owner's manual and look on the "specifications" page to find the frequency range.

When you have the information on your speakers, set the four switches as follows:

1) Front Speaker Mode

This switch determines the frequency range of the front left/right speakers. Select Large or Small depending on the type of speaker you will be using. The factory default setting is "Small".

Large: Set the switch to this position if you are using full range speakers that are capable of reproducing sounds below 100 Hz. In this position, the output to the front left/right output jacks is full range.

This switch position should also be used if you are using a packaged speaker system where the first input feed is to the subwoofer. Although subwoofer/satellite systems normally use the "small" setting, some systems contain a crossover within the subwoofer, and send filtered sounds to small speakers. Consult your dealer or the speaker system's owner's manual if you are uncertain if this is an appropriate setting.

Small: Set the switch to this position if you have small, frequency limited satellite type speakers that do not reproduce sounds below 100 Hz, and whenever a subwoofer is used. Use this setting if you have a subwoofer satellite system where there are separate feeds to your subwoofer and the small satellite speakers (but then an extra subwoofer is necessary for the LFE channel). When the Subwoofer Mode Switch  is in the "ON" position, front Low Frequency Effects (LFE) audio will be routed to the subwoofer.

2) Surround Speaker Mode



This switch determines the frequency range of the rear surround speakers. Select Large, None or Small depending on the type of speakers you will be using. The factory default setting is "Small".

Installation & Setup

7

Large: Set the switch to this position when using traditional full range loudspeakers that are capable of handling sounds below 100 Hz. In this position, the output to the surround output jacks is full range.

None: Set the switch to this position when no surround speakers are connected. In this position the full range surround audio that would otherwise be routed to the surround channels will be mixed in with the FRONT LEFT and FRONT RIGHT audio.

Small: Set the switch to this position when using smaller bookshelf or "satellite" speakers that have limited low frequency range and are unable to reproduce sounds below 100 Hz. When the switch is in the "Small" position all sounds below 100 Hz will be routed to the Subwoofer output jack. When the Subwoofer Speaker Mode switch  is in the "ON" position, LFE surround audio will be routed to the subwoofer. When the Subwoofer Speaker Mode Switch  is in the "OFF" position, LFE surround audio will be routed to the front left/right speakers.

3) Center Speakers Mode

This switch determines the frequency range for the center channel speaker. Select Large, None or Small depending on the type of center channel speaker installed. The factory default setting is "Small".

Large: Set the switch to this position when using traditional full range loudspeakers that are capable of handling sounds below 100 Hz.

None: Set the switch to this position when a center channel speaker is not connected. Full range audio signals that would otherwise be routed to the center channel will be mixed in with the FRONT LEFT and FRONT RIGHT audio.

Small: Set the switch to this position when using a smaller bookshelf or "satellite" center speaker that has limited low frequency range and is unable to reproduce sounds below 100 Hz. When the switch is in the "Small" position, LFE Center audio will be routed to the Subwoofer output, provided that the Subwoofer Speaker Mode Switch  is in the "ON" position. Otherwise it's routed to the front speakers.

4) Subwoofer Mode

Set this switch to determine the routing of low frequency sounds for all channels. The factory default setting is "ON", to indicate that a subwoofer is present.

On: Select this position if the ADP303 is connected to an amplifier or Receiver equipped with a Subwoofer INPUT terminal, or if it is directly connected to a powered subwoofer.

Off: Select this position if a Subwoofer will not be used.

In this position the low frequency sounds (below 100 Hz) will be routed to the FRONT LEFT, RIGHT and/or CENTER terminals, depending on the setting of the speaker switches for those channels.

5) System Reset

Once you have completed any changes to the Speaker Selection Switches turn the ADP303 off, and then on again to enter the settings into the unit's memory for future use.

DELAY TIME ADJUSTMENT

Delay time adjustment enables you to adjust the timing between signals at the front and rear channels. Since the use of the ADP303 may bypass the delay settings in your receiver or preamp it is important to establish a proper delay setting for use in 6 channel operation.

1. Using the remote control or front panel controls appropriate to your receiver, processor or pre-amp, make note of the delay time setting you use for normal surround listening.

2. Press the front panel DELAY  button until the delay time indicator illuminates to show a setting that is closest to that used with your conventional surround system.

SYSTEM CONNECTIONS

The ADP303 may be used in one of three operating modes, depending on the other equipment in your system. Before proceeding to the final adjustments, check to make certain that the ADP303 is connected to the components in your system based on one of the three options shown on the following pages. Note that proper system calibration and operation are dependent on making the right connections and use of the controls as outlined on each page.

If you will be using the ADP303 in conjunction with an AVR80, AVI250 or other AV receiver equipped with direct inputs for a "6 Channel Direct" connection via RCA jacks, use the system configuration shown on page 8.

If you will be using the ADP303 in conjunction with an external preamp or surround sound processor, use the system configuration shown on page 9.

If you will be using the ADP303 in conjunction with an AV receiver equipped with "pre-out/main-in" jacks for all five audio channels, use the system configuration shown on page 10.

Installation & Setup

8

INSTALLATION & CALIBRATION WITH A PRODUCT EQUIPPED FOR 6 CHANNEL DIRECT INPUT

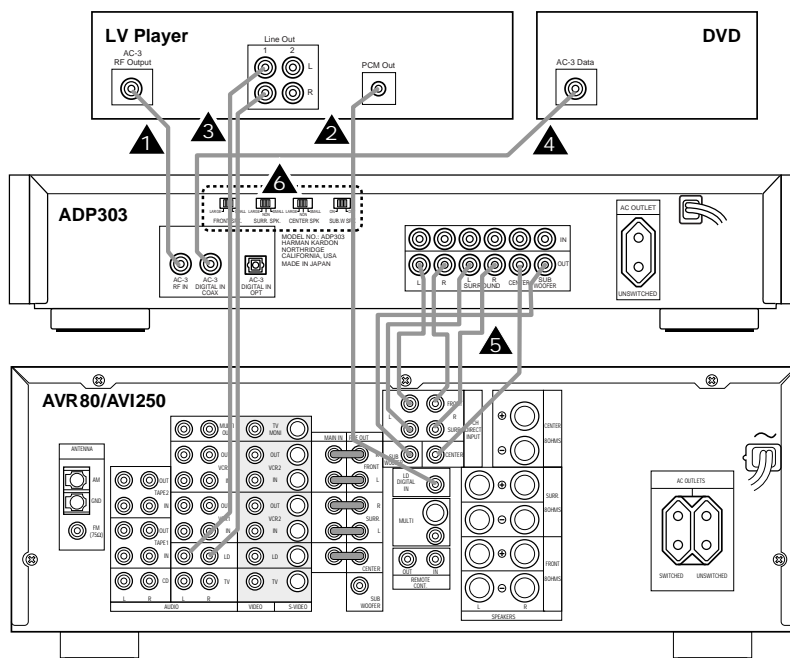

Use this setup for connection to an AVR80, AVI250 or other compatible products equipped with 6 Channel Direct inputs.

1. Connect the AC-3 RF output of a compatible LV player to the ADP303 AC-3 RF In Jack **1**.
2. Connect the optical or coax AC-3 output of a DSS, DVD player or HDTV receiver to the respective input jack **2** on the ADP303.
3. Connect the Analog Line Outputs of the Laser Disc player to the LD inputs of the receiver.
4. Connect the PCM output of the Laser Disc player (if equipped) to the LD Digital input of the AVR80.
5. Connect the Line Out **5** jacks of the ADP303 to the 6 Channel Direct inputs of the AVR80.

6. Set the Speaker Mode switches **6** **7** **8** **9** to their proper positions based on the type of speakers in use.

7. Using the small Allen Key tool supplied with the ADP303, carefully remove the cover panel for the Level Trim Controls **H**. Set the cover aside so that you may replace it later.

8. Turn on the power to both the ADP303 and the receiver or amplifier. Before proceeding further, make certain that the output levels on the receiver or amplifier have been properly adjusted.

9. Press the 6ch Direct Input button of the AVR80 or AVI250.

10. Set the Main Volume Control **I** on the ADP303 to the 12 o'clock position.

11. Press the Test button **F** and hold it for a few seconds. This will start the test tone sequence.

Note that a test signal noise will be heard from the speakers. Verify that test signal circulates in a clockwise direction, stopping for five seconds at each speaker. If

the sound is heard out of order, (i.e., moving from right to left, or appearing out of order), turn the unit off and check the connection from the ADP303 output jacks to the inputs of your AV receiver.

12. Listen to the sound as it moves between the speakers. Ideally, the output from each speaker should be equal. If the output is NOT equal change the level by carefully turning the Output Level Trim Control **H** for the speaker that needs adjustment.

13. When you have completed the adjustments press "Test" button **F** once to stop the Test Tone.

14. Carefully replace the cover for the Level Trim Controls.

15. During normal operation use the AVR80 or AVI250 volume control to adjust the volume level.

Installation & Setup

9

INSTALLATION & CALIBRATION WITH EXTERNAL SURROUND PROCESSORS

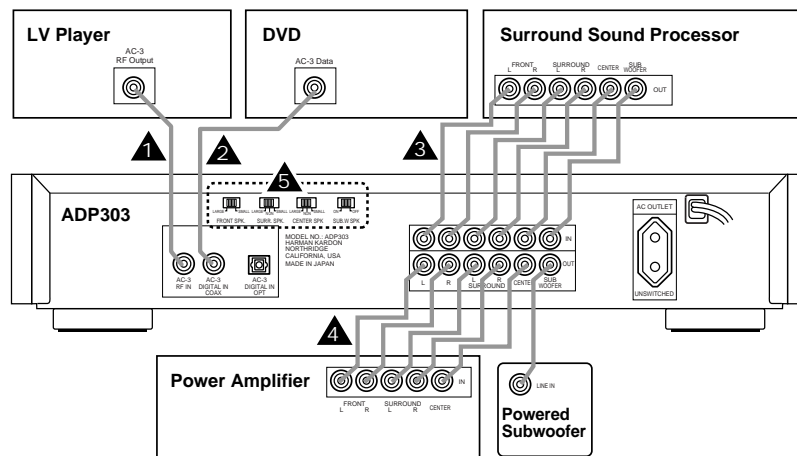

Use this setup for connection to an external surround sound processor or preamplifier.

1. Connect the AC-3 RF output of a compatible LV player to the ADP303 AC-3 RF In Jack **1**.
2. Connect the optical or coax AC-3 output of a DSS, DVD player or HDTV receiver to the respective input jack **2** **3** on the ADP303.
3. Connect the surround outputs of the external processor to the Line Input Jacks **4** of the ADP303.
4. Remove the connections from the external processor to the audio power amplifiers and connect the Line Out **5** jacks of the ADP303.
5. Set the Speaker mode switches **6** **7** **8** **9** to their proper positions based on the type of speakers in use.
6. Using the small Allen key tool supplied with the ADP303, carefully remove the cover panel for the Level Trim Controls **10**. Set the cover aside so that you may replace it later.

7. Turn on the power to both the ADP303 and the external processor.

8. Select one of the three digital inputs on the ADP303. **11**.

9. Set the Main Volume Control **12** on the ADP303 to the 12 o'clock position.

10. Press the Test button **13** and hold it for a few seconds. This will start the test tone sequence.

Note that a test signal noise will be heard from the speakers. Verify that test signal circulates in a clockwise direction, stopping for five seconds at each speaker. If the sound is heard out of order, (i.e., moving from right to left, or appearing out of order), turn the unit off and check the connection from the ADP303 output jacks to the inputs of your audio power amplifiers.

11. Listen to the sound as it moves between the speakers. Ideally, the output from each speaker should be equal. If the output is NOT equal change the level by carefully turning the Output Level Trim Control **10** for the speaker that needs adjustment.

NOTE: If you have trouble getting sufficient output level from the ADP303 trim controls increase the master volume level using the ADP303 volume control **12**. If the volume level is too loud reduce the level of the ADP303 master volume **12**.

12. When you have completed the adjustments press the "Test" **13** button once to stop the Test Tone.

13. Carefully replace the cover for the Level Trim Controls.

14. When listening to a Dolby Digital source use the volume control on the ADP303 **12**. For all other listening set the ADP303 to BYPASS **14**, or turn it off. Use the external processor's volume control for all other (non-Dolby Digital) modes.

Installation & Setup

10

INSTALLATION & CALIBRATION WITH AV RECEIVERS/AMPLIFIERS WITH PRE-OUT/MAIN-IN JACKS

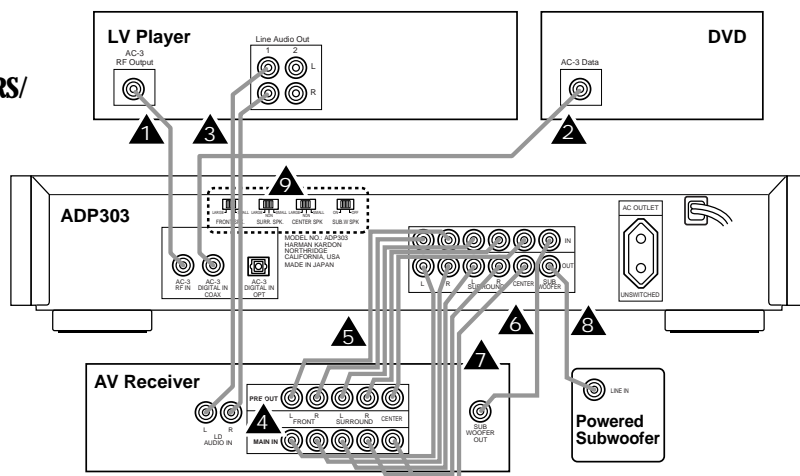

Although AV receivers that have both pre-out/main-in jacks for all five surround channels as well as a subwoofer output were not designed for Dolby Digital applications, you may use them with the ADP303 by using the following steps:

1. Connect the AC-3 RF output of a compatible LV player to the ADP303 AC-3 RF In Jack ①.
2. Connect the optical or coax AC-3 output of a DSS, DVD player or HDTV receiver to the respective input jack ②③ on the ADP303.
3. Connect the Line Audio out from the Laser Disc player to the LD audio input on the receiver.
4. After making certain that the power to your receiver is turned off, remove any jumpers that connect the Pre-out to Main-In jacks on the rear of your AV receiver.
5. Connect the Pre-Out jacks on the receiver to the respective Line Input Jacks ④ (i.e., left to left, center to center, etc.) of the ADP303.
6. Connect the sub out jack on the receiver to the Subwoofer input jack on the ADP303.

7. Connect the Line Out ⑤ jacks of the ADP303 to the Main-In jacks on the rear of your receiver.

8. Connect the ADP303 Subwoofer output jack to a powered subwoofer or a subwoofer amplifier.

9. Set the Speaker mode switches ⑥⑦⑧⑨ to their proper positions based on the type of speakers in use.

10. Using the small Allen wrench tool supplied with the ADP303, carefully remove the cover panel for the Level Trim Controls ⑩. Set the cover aside so that you may replace it later.

11. Turn on the power to both the ADP303 and the AV receiver.

12. Select one of the three digital inputs on the ADP303. ⑪.

13. Set the Main Volume Control ⑫ on the ADP303 to the fully clockwise (lowest volume) position.

14. Press the Test button ⑬ and hold it for a few seconds. This will start the test tone sequence. Raise the volume on the ADP303 ⑭ until you hear the test signal at a level slightly above normal volume.

Note that a test signal noise will be heard from the speakers. Verify that the test signal circulates in a clockwise direction,

stopping for five seconds at each speaker. If the sound is heard out of order, (i.e., moving from right to left, or appearing out of order), turn the unit off and check the connection from the ADP303 output jacks to the inputs of your audio power amplifiers.

15. Listen to the sound as it moves between the speakers. Ideally, the output from each speaker should be equal. If the output is NOT equal change the level by carefully turning the Output Level Trim Control ⑮ for the speaker that needs adjustment.

NOTE: If you have trouble getting sufficient output level from the ADP303 trim controls increase the master volume level using the ADP303 volume control ⑯. If the volume level is too loud reduce the level of the ADP303 master volume ⑯.

16. When you have completed the adjustments, press the "Test" ⑰ button once to stop the Test Tone.

17. Carefully replace the cover for the Level Trim Controls.

18. When listening to a Dolby Digital source use the volume control on the ADP303 ⑱. For all other listening set the ADP303 to BYPASS ⑲, or turn it off. Use the A/V Receiver's volume control for all other (non-Dolby Digital) modes.

Operation and Specifications

11

NORMAL OPERATION

1. Turn the power on. **A**
2. Select the appropriate input source **D** (i.e., "RF" for a laser disc player, "Coax" or "Optical" for data stream sources such as DSS, DVD or HDTV).
3. Start playback source equipment.
4. Note that the AC-3 indicator will illuminate when the unit is locked to the digital signal and is functioning properly.
5. Depending on the equipment in your specific home theater installation, you will use either the volume control on your AVR80 or "6 Channel Equipped"

receiver, or the front panel volume control on the ADP303 **I**. Choose the option below that describes your system.

- When the ADP303 is used with the AVR80 or another product with a 6 Channel Direct mode make the appropriate input selection on the receiver. Make certain that the ADP303 front panel volume control **I** is set to the 12 o'clock position. Use the volume control or the remote for the AVR80, AVI250 or other device to control system volume levels.
- When using the ADP303 with any other product, the volume is controlled by the front panel volume control on the ADP303 **I** while listening to an AC-3 source

6. To temporarily silence the ADP303's audio output press the MUTE button. Press it again to return to normal volume levels.

7. To take the ADP303 out of the system when it is used with products other than those with a 6 Channel Direct mode, (e.g., where it is installed between the preamp/receiver and power amplifiers and no AC-3 source will be listened) press the BYPASS button. Note that the ADP303 will automatically revert to the BYPASS mode when it is turned off. Use of the Bypass control is not required when the ADP303 is used with products such as the AVR80 or AVI250 that feature a 6 Channel Direct input.

SPECIFICATIONS

Output Level/Output Impedance

MAIN L/R, CENTER, SURROUND L/R	0~3.5 V/500 Ω
1 kHz, 0 dB INPUT	
SUBWOOFER	0~9 V/500 Ω
50 Hz, 0 dB INPUT	
Input Impedance (RF, COAXIAL)	75 Ω
Frequency Response	
MAIN L/R, CENTER, SURROUND L/R (LARGE)	0± dB
20 Hz~20 kHz	
Filter Characteristics	
MAIN L/R, CENTER, SURROUND L/R (SMALL)	
H.P.F.	fc=100 Hz, 12 dB/oct.
SUBWOOFER	
L.P.F.	fc=100 Hz, 24 dB/oct.

Total Harmonic Distortion

MAIN L/R, CENTER, SURROUND L/R (1 kHz)	0.01% or less
SUBWOOFER (50Hz)	0.1% or less
Signal to Noise Ratio (IHF - A)	98 dB
Channel Separation (1 kHz)	80 dB
Power Consumption	30 W
AC OUTLET: UNSWITCHED	200 W max.
Dimensions (W/H/D)	444 mm x 85 mm x 278 mm
	17-3/8 in x 3-3/8 in x 10-7/8 in
Weight	4.2 kg. (9.4 lbs.)

Troubleshooting Guide

12

If your trouble cannot be resolved with the actions listed in the following table, immediately unplug the power cable and contact your dealer or authorized Harman Kardon Service Depot.

SYMPTOM	CAUSE	SOLUTION
The unit fails to turn on when the POWER switch is pressed.	<ul style="list-style-type: none"> Power cord is not plugged in or is not completely inserted. 	<ul style="list-style-type: none"> Firmly plug in the power cord.
No sound.	<ul style="list-style-type: none"> Incorrect input or output cord connections. Improper input mode selection. Improper input mode selection on the amplifier. 	<ul style="list-style-type: none"> Connect the cords properly. If the problem persists, the cords may be defective. Select the proper input mode (RF, OPT or COAX). Select the "6 channel Direct" mode on the AVR80 or receiver.
Sound "hums."	<ul style="list-style-type: none"> Incorrect cord connections. 	<ul style="list-style-type: none"> Firmly connect the audio plugs. If the problem persists, the cords may be defective.
Sound output level to either one or both of the rear surround speakers is lower than other speakers.	<ul style="list-style-type: none"> Sound output level to either one or both of the rear surround speakers is decreased. 	<ul style="list-style-type: none"> Increase the level.
No sound from the center speaker.	<ul style="list-style-type: none"> The setting of CENTER speaker is at the none position. 	<ul style="list-style-type: none"> Select the SMALL or LARGE position.
Whole sound level is low, even though the volume is increased on the amplifier.	<ul style="list-style-type: none"> Volume level adjustment on this unit is low. 	<ul style="list-style-type: none"> Increase the level.
Noise from nearby TV or tuner.	<ul style="list-style-type: none"> This unit is too close to the affected equipment. 	<ul style="list-style-type: none"> Move this unit further away from the affected equipment.

All specifications are subject to change without notice.

Dolby, Dolby Digital, ProLogic and AC-3 are registered trademarks of Dolby Laboratories Licensing Corp.

Declaration of Conformity



We, Harman Kardon Europe A/S
Kongevejen 194B
DK-3460 Birkerød
DENMARK

declare in own responsibility, that the
product described in this owner's
manual is in compliance with
technical standards:

EN 55 013/6.1990
EN 55 020/6.1988
EN 55 022/6.1993
EN 60 065/1994
EN 60 555-2-3/1987/88

A handwritten signature in black ink, appearing to read 'Steen Michaelsen'.

Steen Michaelsen
Harman Kardon Europe A/S
Birkerød, DENMARK, 3/96

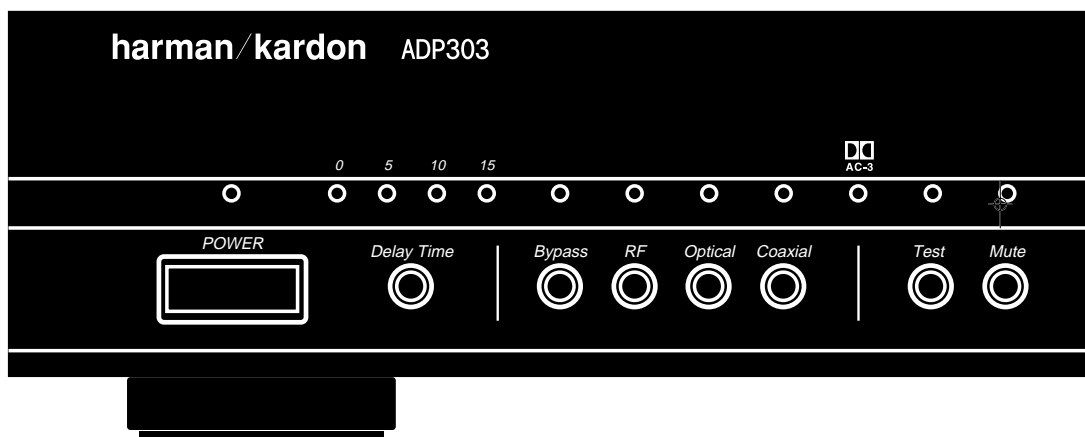

Printed in Japan
Part #1111-ADP303E
267 J851310





Harman Kardon ADP303 Dolby® Digital Decoder

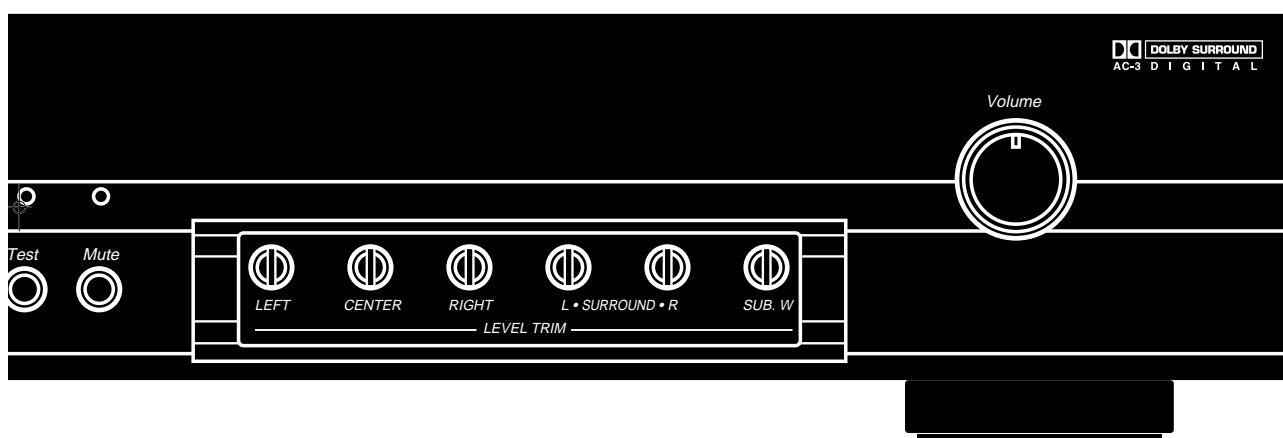

Owner's Manual

harman/kardon

